

#RECYCLINGMADEEASY

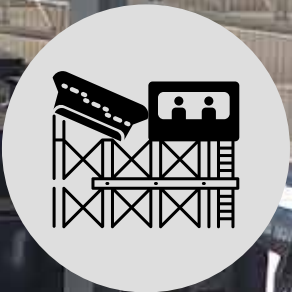

WE OFFER MUCH MORE THAN YOU EXPECT

WE DO EVERYTHING WE CAN TO ENSURE UPTIME AND MAKE YOUR PRODUCTION AS TROUBLE-FREE AND EFFICIENT AS POSSIBLE. OVER 40 YEARS OF EXPERIENCE GUARANTEE THAT YOU GAIN CONSTANT BENEFITS DURING THE ENTIRE PRODUCT/PROJECT LIFE CYCLE.



when it all began

1977

m2 facilities

6000

completed projects

100's

products delivered

1000's

**WE ARE THE
LEADING AND MOST
EXPERIENCED
MANUFACTURER
OF STATIC AND
MOBILE WASTE
RECYCLING
EQUIPMENT**





INVESTING IN THE FUTURE

WE DESIGN, MANUFACTURE AND SUPPORT
STATIC & MOBILE WASTE RECYCLING EQUIPMENT

Our production facility encompasses over 6,000 square meters of privately owned facilities. These facilities include product design, manufacturing, surface treatment, assembly, spare part warehousing, automation & control assembly & test, testing, prototyping and administration offices. Our experienced workforce is supported with automation.



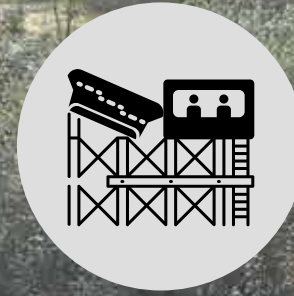

DESIGN, MANUFACTURE AND SUPPORT

WE DESIGN, MANUFACTURE AND SUPPORT
STATIC & MOBILE WASTE RECYCLING EQUIPMENT

- Laser Cutting
- Fabrication
- Surface Treatment
- Subassembly
- Final Assembly
- Research & Development
- Testing/Quality Control
- Warehousing
- Global Distribution Centre

C&D

C&I

RDF

SRF

METALS
COMPOST

DMR

PAPER

BIOMASS



#RECYCLINGMADEEASY

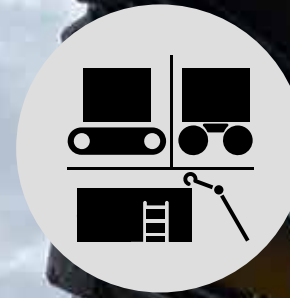

THE FUTURE IS GREEN

THE FUTURE IS HYBRID TECHNOLOGY.

We are the Number 1 innovator in Hybrid Technology in our sector by developing innovations that offer solutions for the preservation of resources and environmental protection.



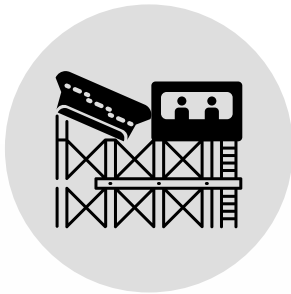

STATIC

ROBOTIC WASTE RECYCLING

Incorporating Sizing, Screening, Density Separation, Metals Recovery and a 3 Armed Zen Robotics Recycler Unit

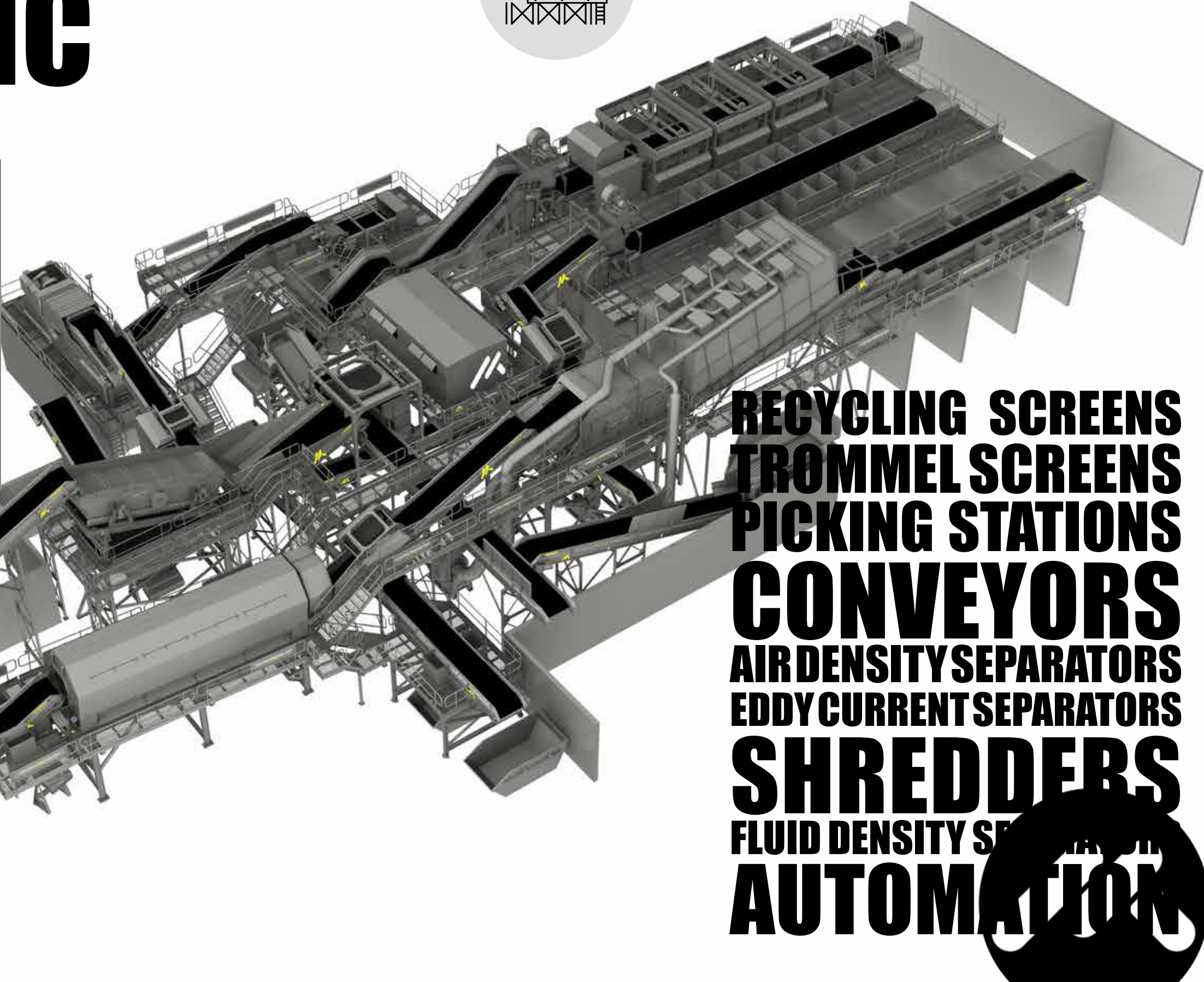

RECYCLING SCREENS
TROMMEL SCREENS
PICKING STATIONS
CONVEYORS
AIR DENSITY SEPARATORS
EDDY CURRENT SEPARATORS
SHREDDERS
FLUID DENSITY SEPARATORS
AUTOMATION



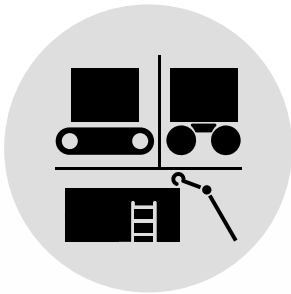

MOBILE



RECYCLING SCREENS
TROMMEL SCREENS
PICKING STATIONS
CONVEYORS
AIR DENSITY SEPARATORS
EDDY CURRENT SEPARATORS
SHREDDERS
FLUID DENSITY SEPARATORS



MODULAR



#RECYCLINGMADEEASY



RECYCLING SCREENS
TROMMEL SCREENS
PICKING STATIONS
CONVEYORS
AIR DENSITY SEPARATORS
EDDY CURRENT SEPARATORS
SHREDDERS
FLUID DENSITY SEPARATORS
AUTOMATION





BUILT TO LAST

INNOVATE DESIGN, DURABLE MATERIALS,
ROBUST CONSTRUCTION

Safeguarding your investment is our priority. Product wear due to application, fatigue and time are considered during the design phase. To prolong uptime we simplify the parts that compromise a complex whole assembly and apply strict quality controls at every stage. We source the best raw materials.

**RS514T
TRACK RECYCLING SCREEN**

Diesel-electric/Dual
Powered, quick simple
setup, 5G Recycling
Screen with Flow Flow Bottom
and on-board stackers ensures
the lowest cost of total owner-
ship

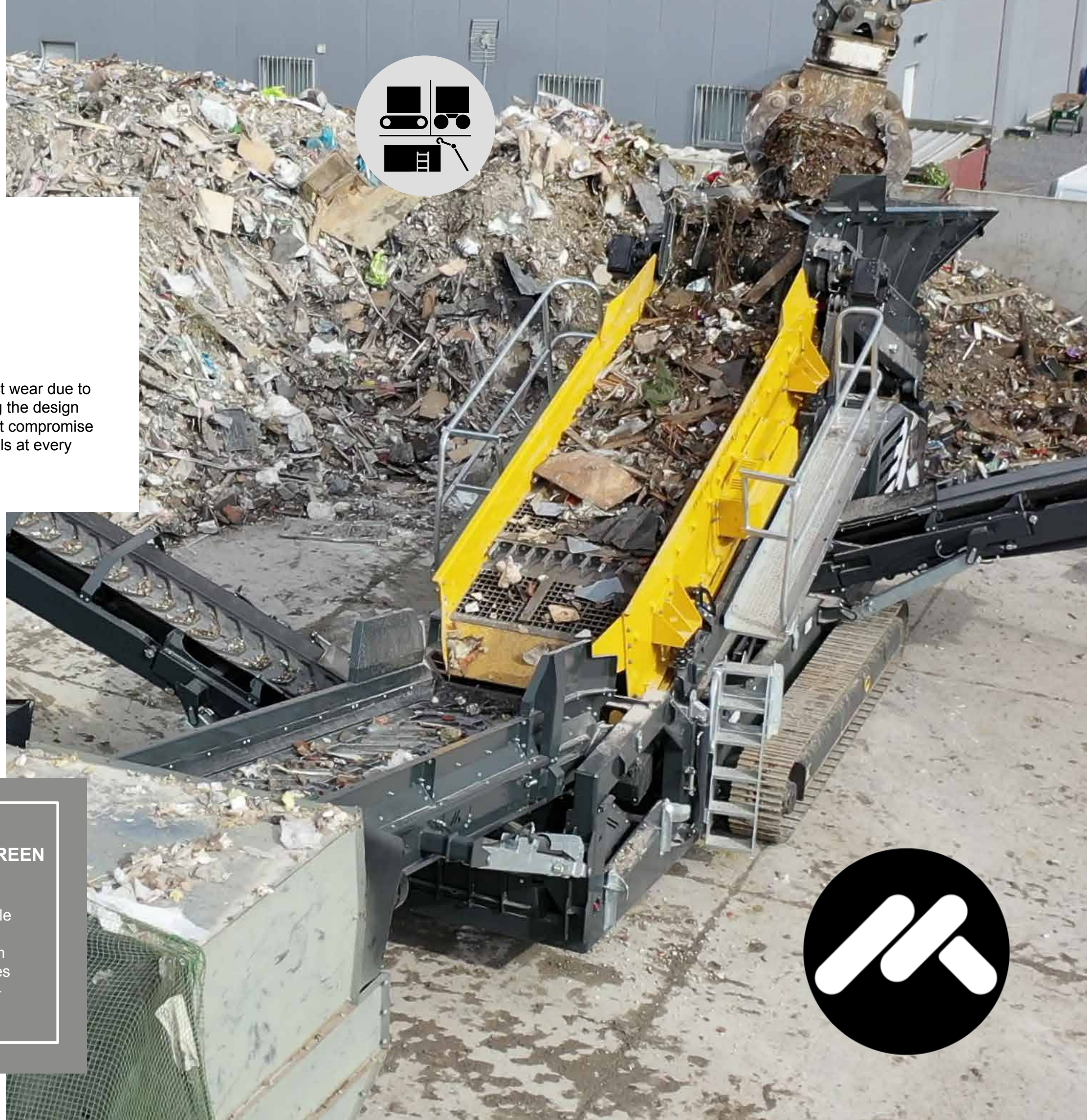

AS150T

AIR DENSITY SEPARATOR

#RECYCLINGMADEEASY

Patent Pending

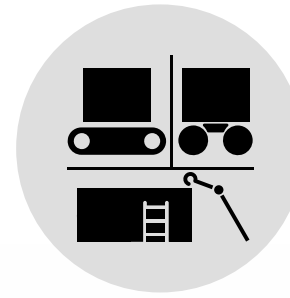

- | | |
|--|--|
| <p>1 Feed Conveyor & Hopper
1300mm Chevron
Dual Drive
VSD</p> | <p>2 Powerpack
Dual Power
60kva Generator
30kW Hydraulic PowerPack
Touch Screen HMI</p> |
| <p>3 Vibrating Feeder
1400mm
Stainless Steel
Hyd Angle Adjustment
Wear Plates
VSD</p> | <p>4 Magnet
Bi Directional
Hydraulic Adjustment
(300mm Max)</p> |
| <p>5 Air Separation Module
2 x 11kw Blowers
Adjustable Nozzle
VSD</p> | <p>6 Accelerator Belt
1500mm
Hydraulic Adjustment In Out
 Up Down
VSD</p> |
| <p>7 Splitter Drum
1800mm
VSD</p> | <p>8 Decompression Chamber
Decompression Fan
VSD</p> |
| <p>9 Heavy Fraction Conveyor
900mm Chevron
VSD</p> | <p>10 Lights Conveyor
1200mm</p> |

Combines with:

EC315T
PS312M, PS212T, PS312W
RS514T
TS620T

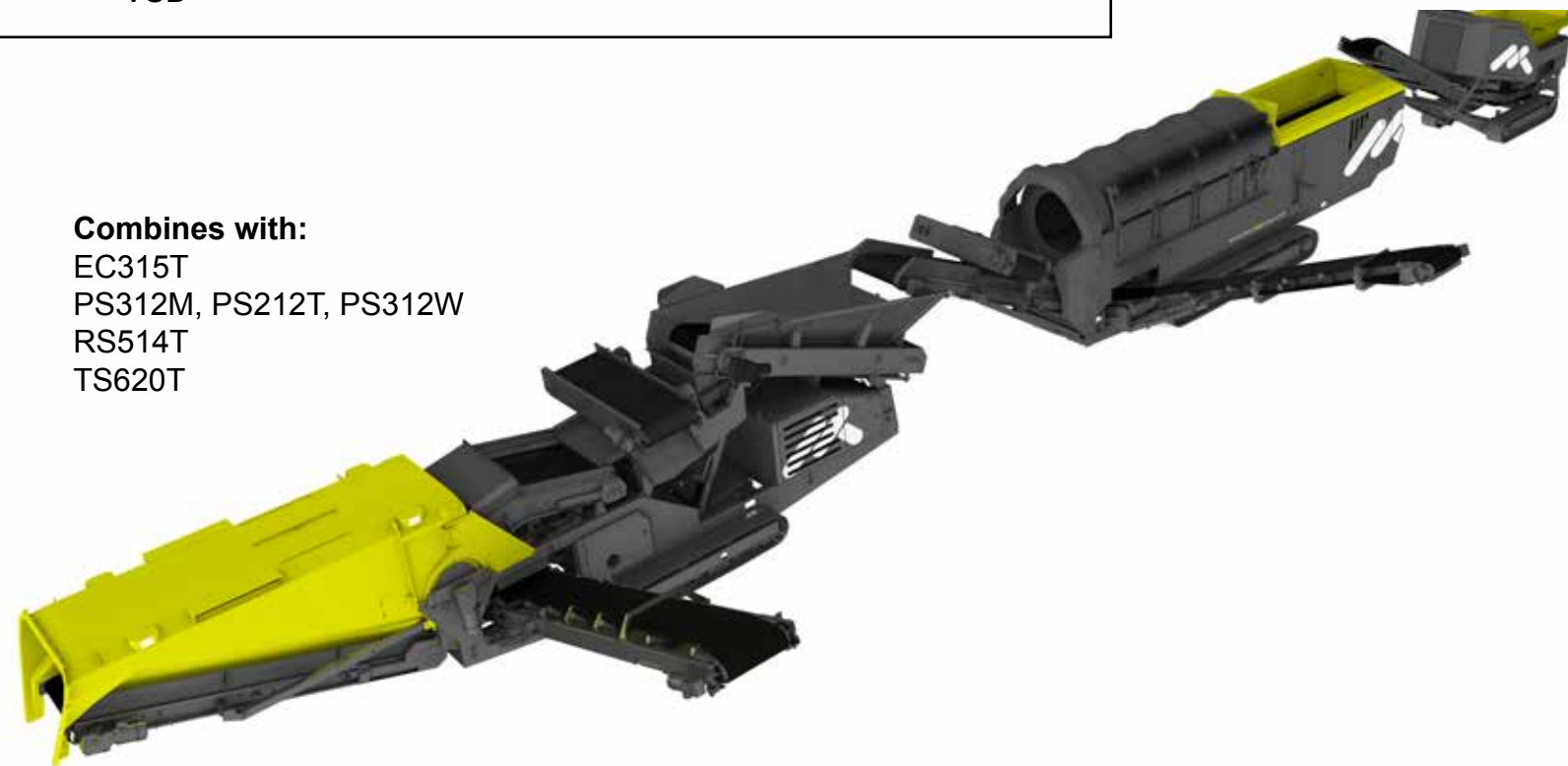

Transport

Width (m) : 2.9
Length (m) : 15.5
Height (m) : 3.2

Working

Width (m) : 8.3
Length (m) : 15.3
Height (m) : 3.2

Weight (kgs) : 25,000 * Weight (kgs) : 25,000 *

* All dimensions and weights are approximate. M&K reserves the right to alter specification without notice. Images may show optional equipment



#RECYCLINGMADEEASY

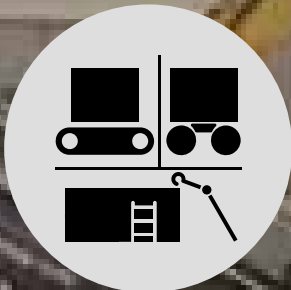

**AS150T
TRACK AIR SEPARATOR**

Dual Powered, quick simple setup, Low level Belt Feeder, Vibrating Feeder, Magnet & Air Separation Chamber



EC315T

EDDY CURRENT SEPARATOR

#RECYCLINGMADEEASY

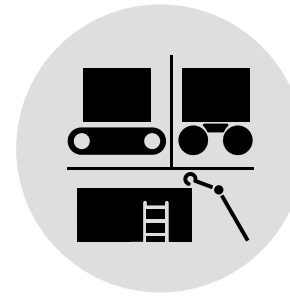

- 1 **Feed Conveyor & Hopper**
1300mm Chevron
Dual Drive
VSD
- 2 **Powerpack**
Dual Power
30kva Generator
30kW Hydraulic PowerPack
Touch Screen HMI
- 3 **Vibrating Feeder**
1400mm
Stainless Steel
Hyd Angle Adjustment
Wear Plates
VSD
- 4 **Magnet**
Bi Directional
Hydraulic Adjustment
(300mm Max)
- 5 **Eddy Current**
1500mm Usable width
24 Pole Concentric Rotor
Fast Belt Change
VSD
- 6 **Splitter System**
Finite X&Y Adjustment
Real Time Adjustment
- 7 **Residual Conveyor**
900mm Chevron
VSD



Combines with:

AS150T
PS312M, PS212T, PS312W
RS514T
TS620T



Transport

Width (m) : 2.9
Length (m) : 10.5
Height (m) : 3.2

Weight (kgs) : 22,000 *

Working

Width (m) : 8.3
Length (m) : 15.3
Height (m) : 3.2

Weight (kgs) : 22,000 *

* All dimensions and weights are approximate. M&K reserves the right to alter specification without notice. Images may show optional equipment



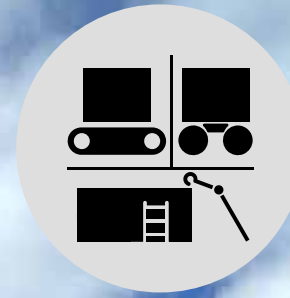

LOWEST TOTAL COST PER TON

WE ARE DEDICATED TO HELPING YOU REALISE THE LOWEST COST-PER-TON POSSIBLE USING OUR RECYCLING EQUIPMENT

A lot goes into delivering that value. Longer maintenance cycles. Longer component life expectancy. High reliability. We follow a proven design philosophy that focuses around 3 main areas:

1. Investments in R&D
2. Supporting Products & Productivity
3. Listening to our customers

EC315T TRACK EDDY CURRENT

Dual Powered, quick simple setup, Low level Belt Feeder, Vibrating Feeder, Magnet & Eddy Current Separator with 24 Pole, Concentric Rotor.



PS312M

MODULAR PICKING STATION - 3 BAY

#RECYCLINGMADEEASY

Patent Pending

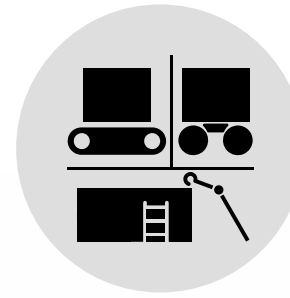

1 **Air Separator**
15 Kw
Hydraulic In & Out
Hydraulic Out of Line
VSD

2 **Powerpack**
Dual Power
60kva Generator
30kW Hydraulic PowerPack
Touch Screen HMI

3 **Picking Cabin**
3 Bay
6 Chutes
Metal Construction

4 **Picking Conveyor**
1200mm
VSD

5 **Magnet**
Bi Directional
Height Adjustable
450 Gauss @ 300mm

6 **Chassis**
Hydraulic Jacklegs
Radio Control
Site Axle
Towbar

Combines with:

AS150T
EC315T
PS312M, PS212T, PS312W
RS514T
TS620T

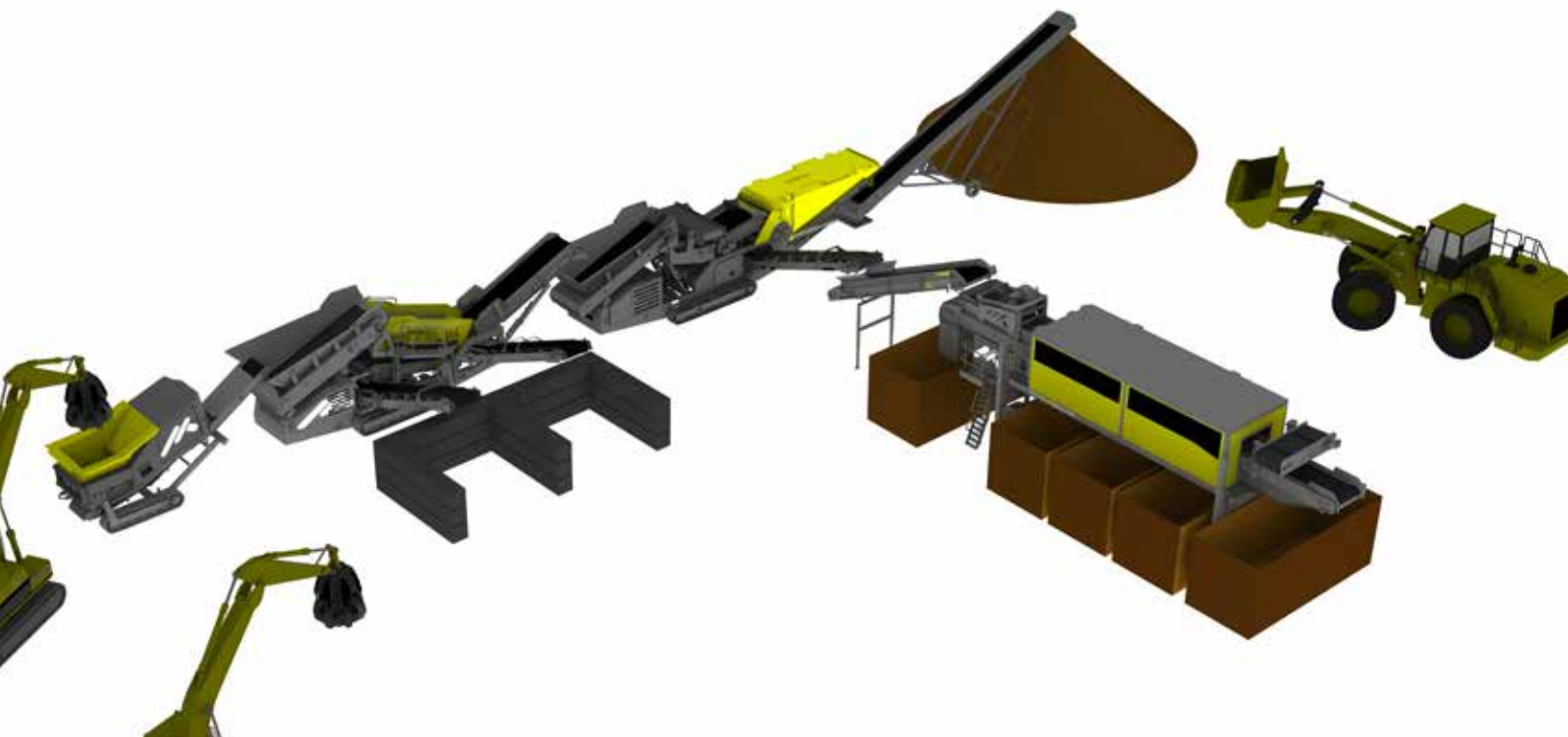
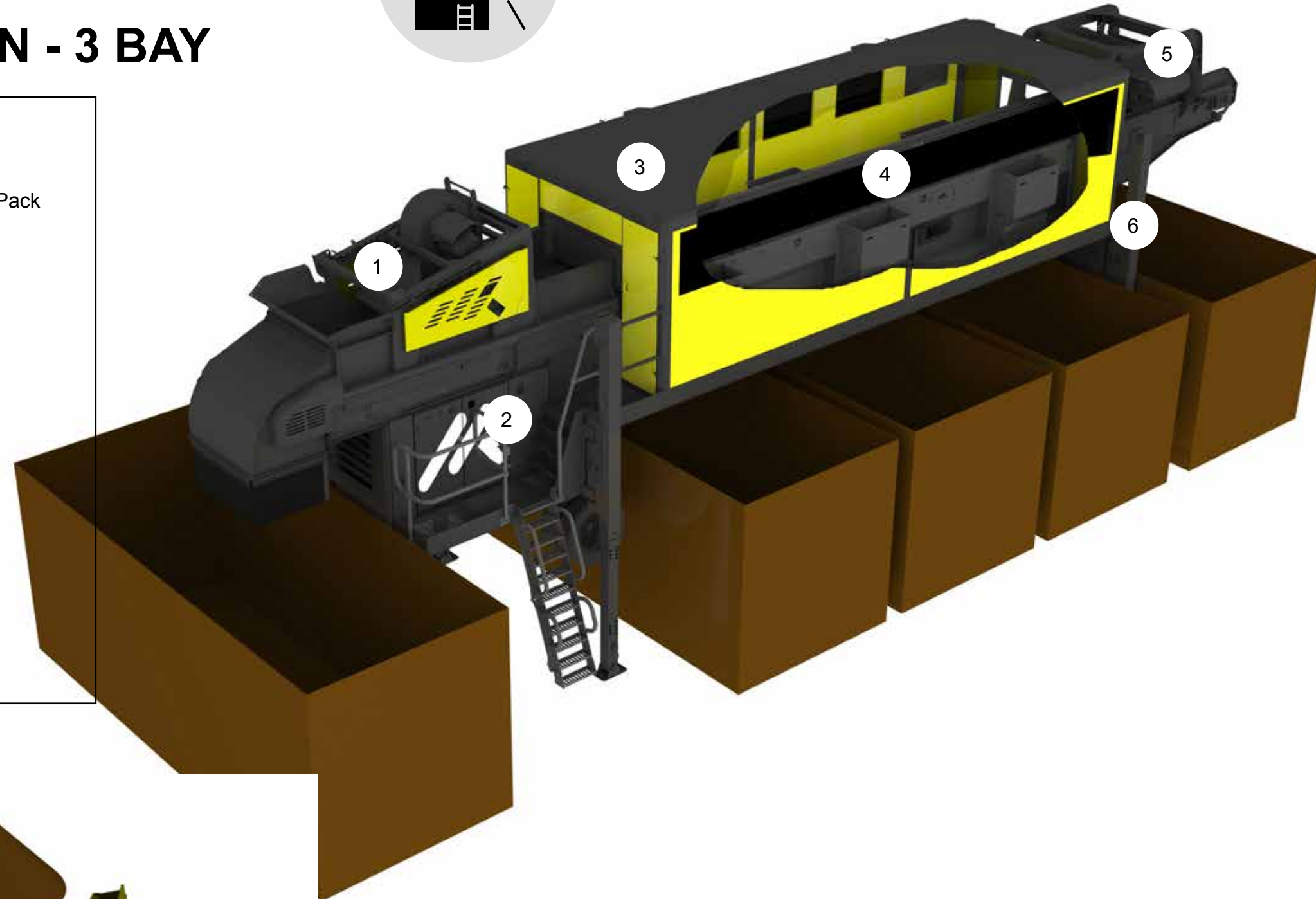

Transport

Width (m) : 3.0
Length (m) : 16.1
Height (m) : 3.2

Working

Width (m) : 5.3
Length (m) : 16.1
Height (m) : 3.2

Weight (kgs) : 21,000 *

Weight (kgs) : 21,000 *

* All dimensions and weights are approximate. M&K reserves the right to alter specification without notice. Images may show optional equipment



#RECYCLINGMADEEASY



MPS312

#recyclingmadeeasy
www.the-mkgroup.com

**PS312M
MOBILE PICKING STATION**

Dual Powered, Air Separator, 3 Bay Picking Cabin, Magnet, Self Erecting, Quick Simple Set Up.



PS212T

TRACK PICKING STATION - 2 BAY

#RECYCLINGMADEEASY

Patent Pending

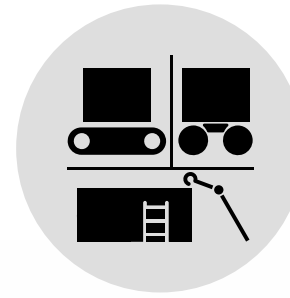

- 1 **Feed Conveyor & Hopper**
1200mm Chevron
Dual Drive
VSD
- 2 **Powerpack**
Dual Power
60kva Generator
30kW Hydraulic PowerPack
Touch Screen HMI
- 3 **Air Separator**
15 Kw
Hydraulic In & Out
Hydraulic Out of Line
VSD
- 4 **Picking Cabin**
2 Bay
4 Chutes (Side)
Metal Construction
- 5 **Picking Conveyor**
1200mm
VSD
- 6 **Magnet**
Bi Directional
Height Adjustable
450 Gauss @ 300mm
- 7 **Discharge Conveyor**
1200mm Chevron

Combines with:
AS150T
EC315T
PS312M, PS212T, PS312W
RS514T
TS620T

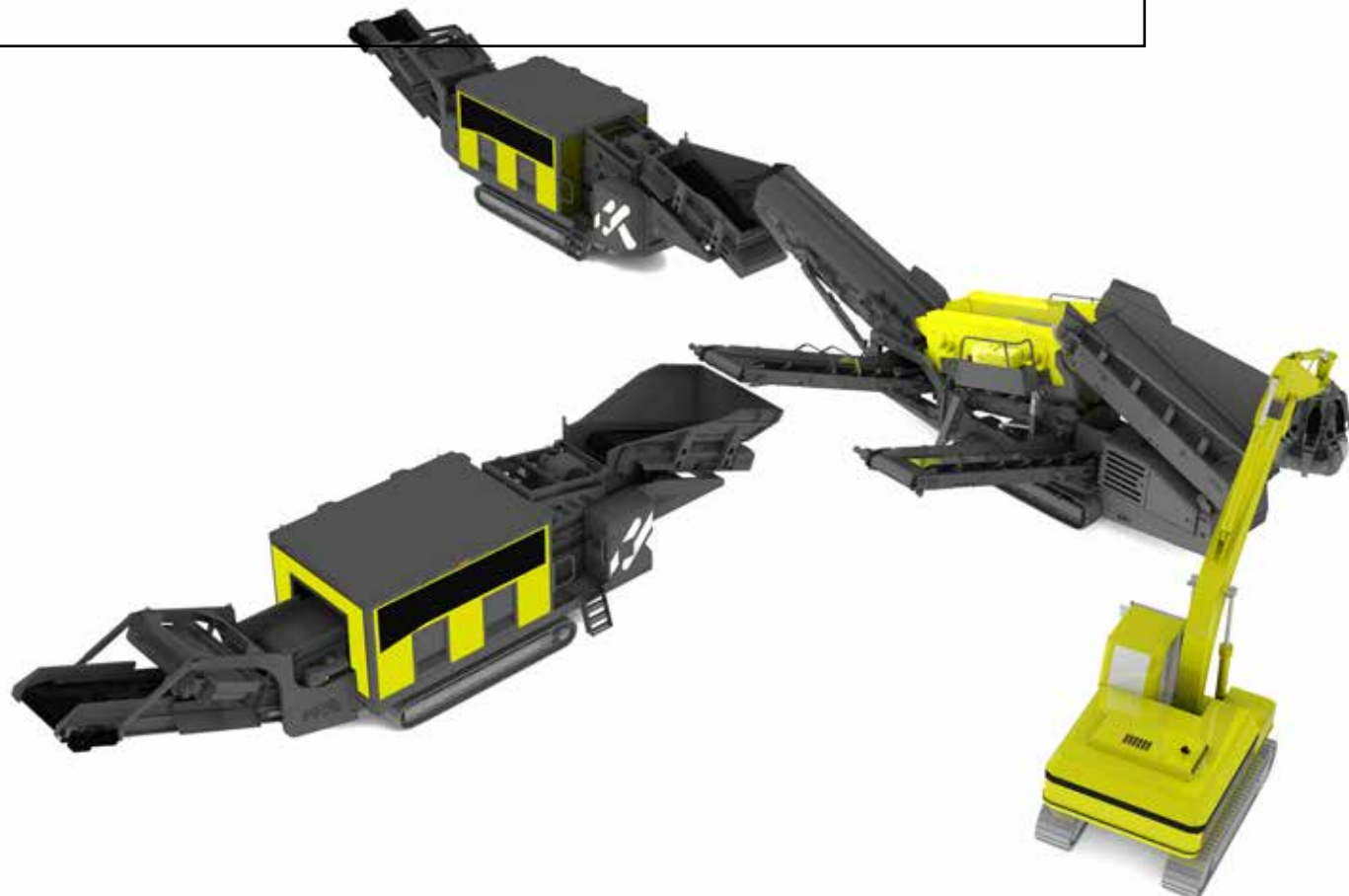
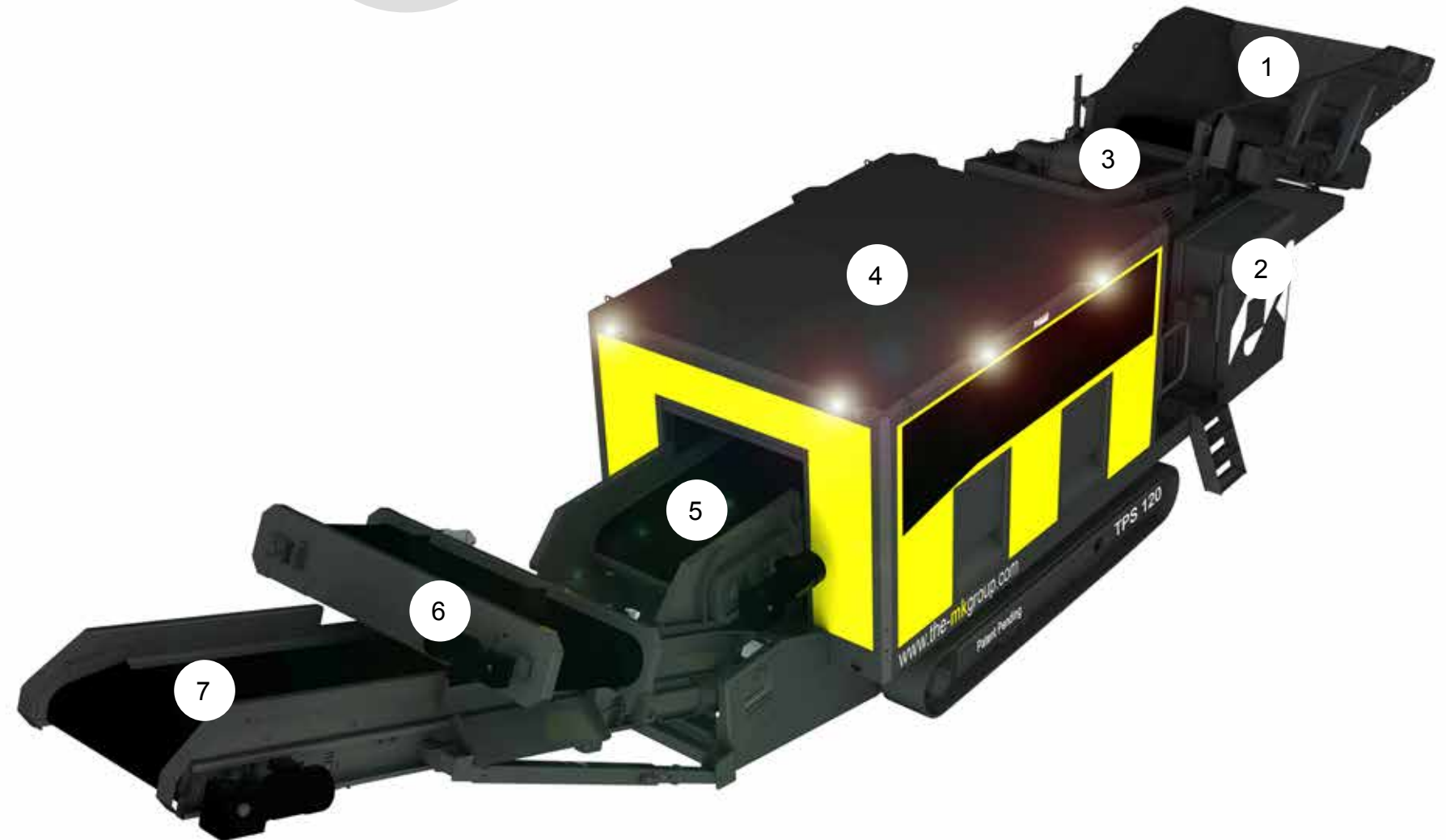

Transport

Width (m) : 3.0
Length (m) : 15.0
Height (m) : 3.1

Weight (kgs) : 20,000 *

Working

Width (m) : 3.0
Length (m) : 15.0
Height (m) : 3.1

Weight (kgs) : 20,000 *

* All dimensions and weights are approximate. M&K reserves the right to alter specification without notice. Images may show optional equipment



#RECYCLINGMADEEASY

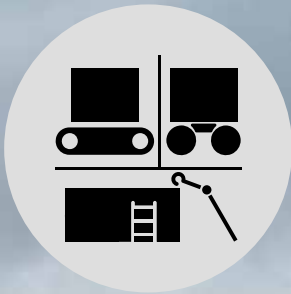

**PS212T
TRACK PICKING STATION**

Dual Powered, Variable Speed Feeder, Air Separator, 2 Bay Picking Cabin, Magnet, Tracks



PS312W

WHEELED PICKING STATION - 3 BAY

#RECYCLINGMADEEASY

Patent Pending

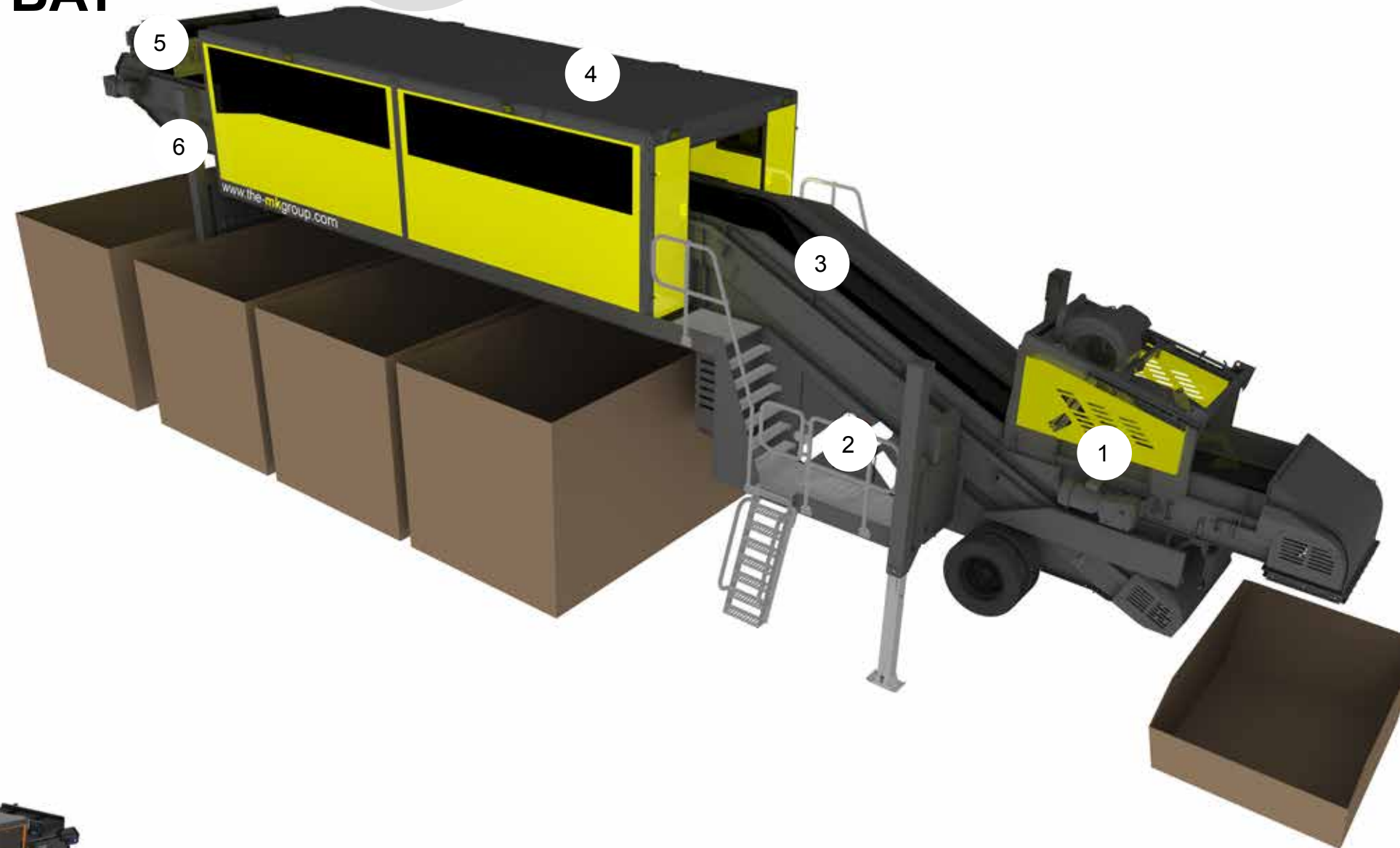
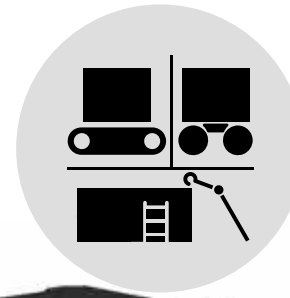

1 **Air Separator**
15 Kw
Hydraulic In & Out
Hydraulic Out of Line
VSD

2 **Powerpack**
Dual Power
60kva Generator
30kW Hydraulic PowerPack
Touch Screen HMI

3 **Picking Cabin**
3 Bay
6 Chutes
Metal Construction

4 **Picking Conveyor**
1200mm
VSD

5 **Magnet**
Bi Directional
Height Adjustable
450 Gauss @ 300mm

6 **Chassis**
Hydraulic Jacklegs
Radio Control
Site Axle
Towbar

Combines with:

- AS150T
- EC315T
- PS312M, PS212T, PS312W
- RS514T
- TS620T



Transport

Width (m) : 3.0
Length (m) : 19.0
Height (m) : 3.2

Working

Width (m) : 5.3
Length (m) : 19.0
Height (m) : 3.2

Weight (kgs) : 25,000 *

Weight (kgs) : 25,000 *

* All dimensions and weights are approximate. M&K reserves the right to alter specification without notice. Images may show optional equipment



#RECYCLINGMADEEASY

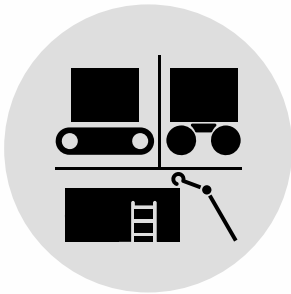

RS514T

RECYCLING SCREEN

#RECYCLINGMADEEASY

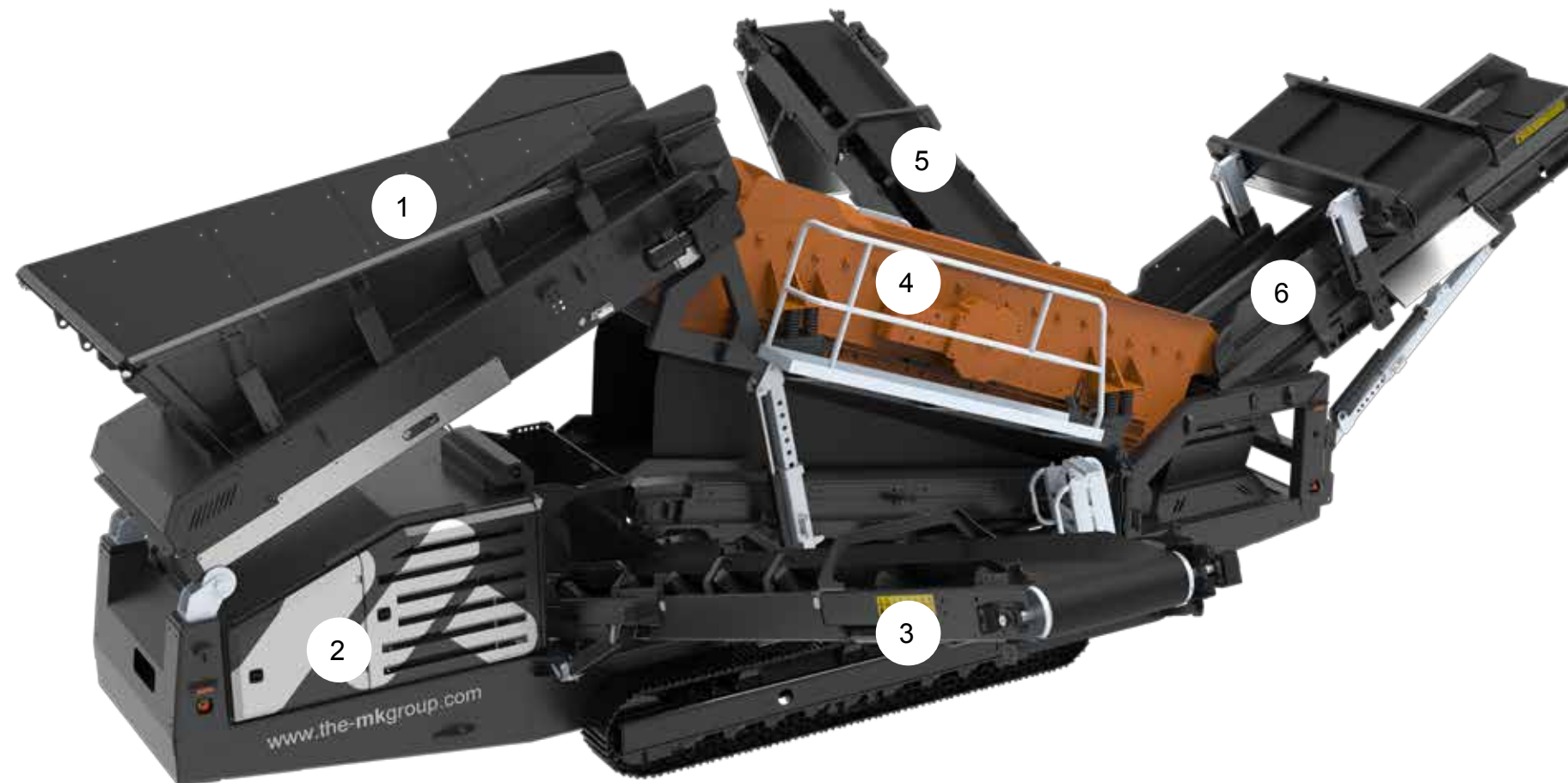
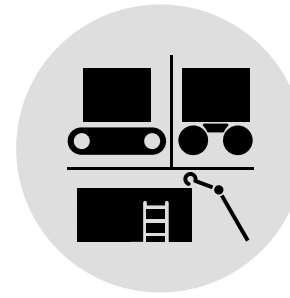

- 1 **Feed Conveyor & Hopper**
1300mm Chevron
Dual Drive
VSD
- 2 **Powerpack**
Dual Power
60kva Generator
30kW Hydraulic PowerPack
Touch Screen HMI
- 3 **Fines Conveyor**
900mm
VSD
- 4 **Recycling Screen**
5000mm x 1400mm
3D Top Deck
Flip Flow Bottom Deck
Hydraulic Drive
- 5 **Mid Size Conveyor**
900mm
VSD
- 6 **Oversize Conveyor**
1200mm Chevron
VSD

Combines with:
AS150T
EC315T
PS312M, PS212T, PS312W
RS514T
TS620T



Transport

Width (m) : 3.0
Length (m) : 16.0
Height (m) : 3.2

Weight (kgs) : 30,000 *

Working

Width (m) : 14.0
Length (m) : 14.6
Height (m) : 3.2

Weight (kgs) : 30,000 *

* All dimensions and weights are approximate. M&K reserves the right to alter specification without notice. Images may show optional equipment



#RECYCLINGMADEEASY

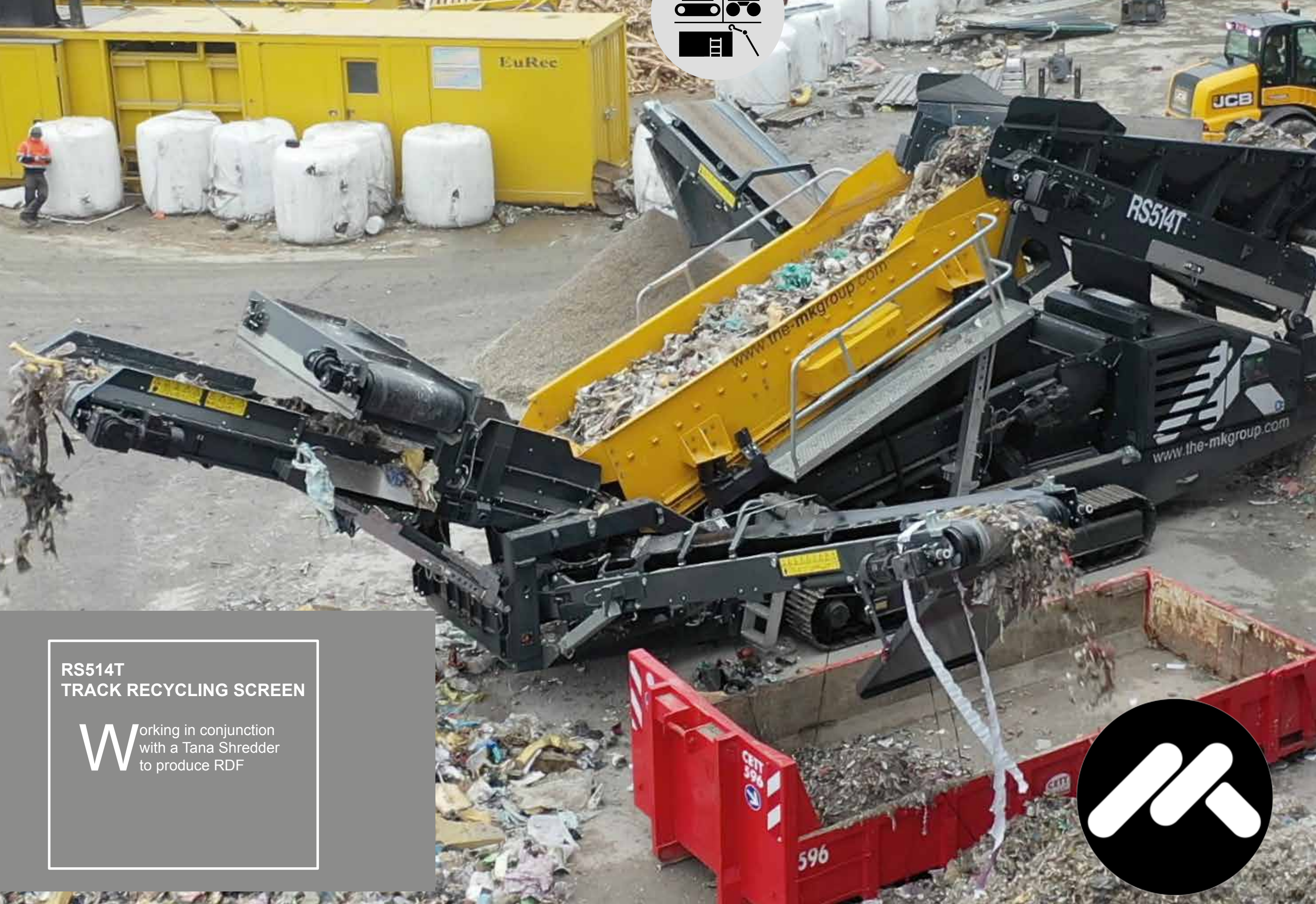

RS514T
TRACK RECYCLING SCREEN

Working in conjunction
with a Tana Shredder
to produce RDF



TS620T

TROMMEL SCREEN

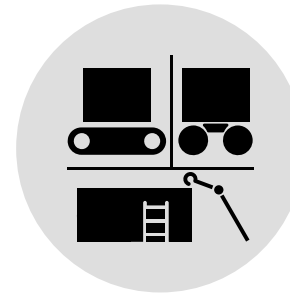

#RECYCLINGMADEEASY

Patent Pending

3 Way Split Option



- 1 **Feed Conveyor & Hopper**
1300mm Chevron
Dual Drive
VSD
- 2 **Powerpack**
Dual Power
60kva Generator
30kW Hydraulic PowerPack
Touch Screen HM
- 3 **Fines Conveyor**
900mm
VSD
- 4 **Trommel Screen**
6000mm x 2000mm
Heavy Duty Welded Design
Bolt in Mesh
4 Wheel Drive - Hydraulic
- 5 **Oversize Conveyor**
1200mm Chevron
VSD

Combines with:

AS150T
EC315T
PS312M, PS212T, PS312W
RS514T
TS620T



Transport

Width (m) : 3.0
Length (m) : 18.0
Height (m) : 3.8

Weight (kgs) : 30,000 *

Working

Width (m) : 3.0
Length (m) : 14.8
Height (m) : 3.8

Weight (kgs) : 30,000 *

* All dimensions and weights are approximate. M&K reserves the right to alter specification without notice. Images may show optional equipment



#RECYCLINGMADEEASY

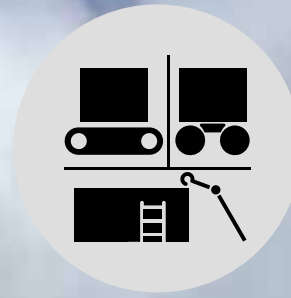

#RECYCLINGMADEEASY

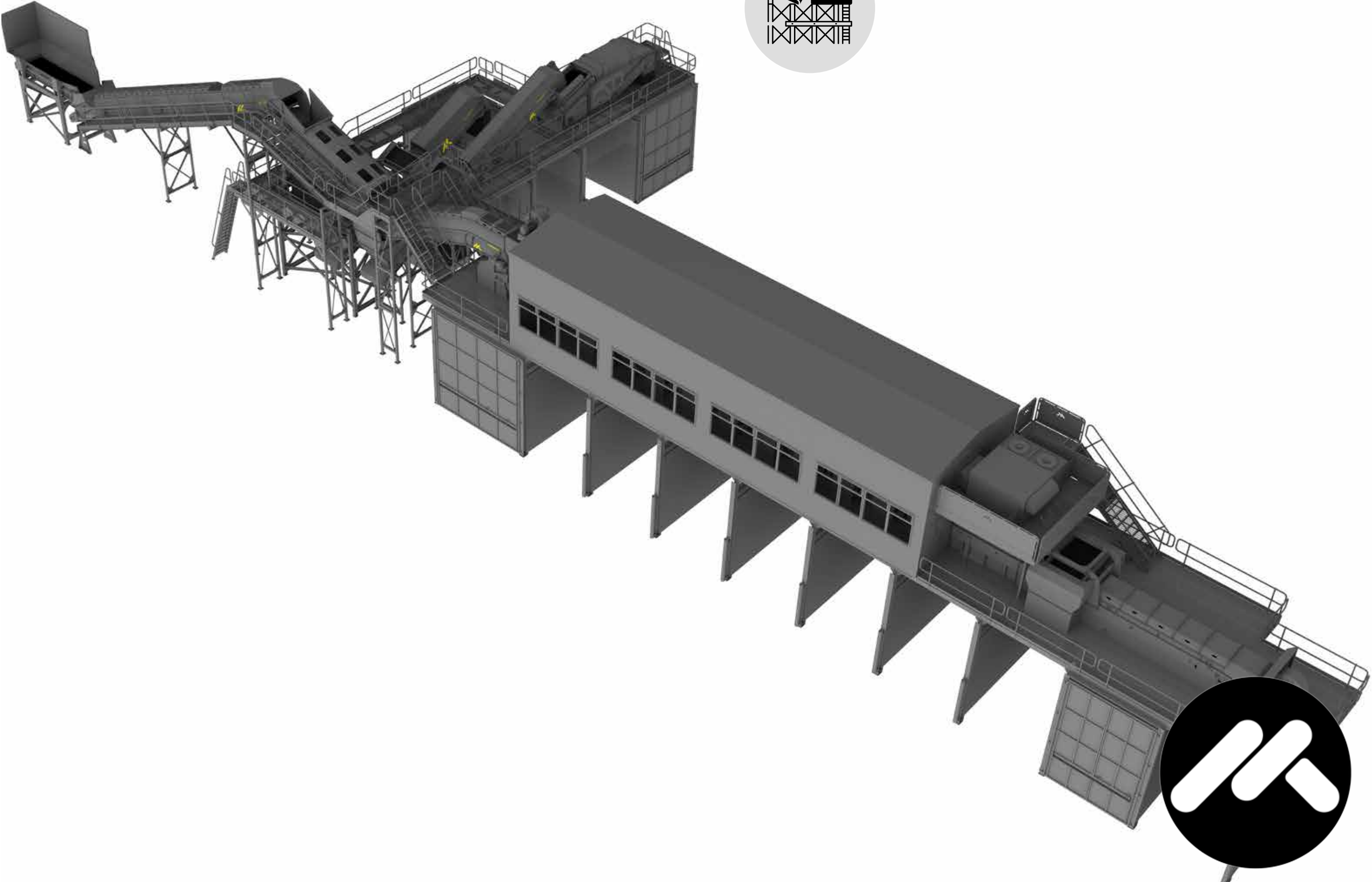
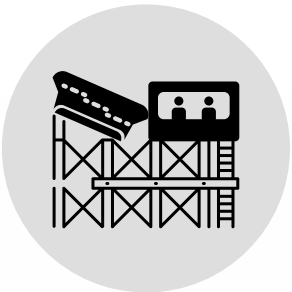

#RECYCLINGMADEEASY

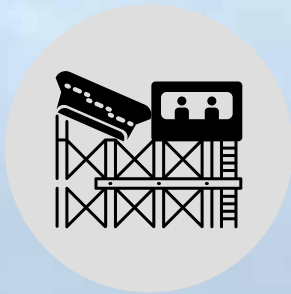

TAILOR-MADE TO YOUR NEEDS

WASTE RECYCLING IS COMPLEX AND DEMANDING. OUR SOLUTIONS ARE SPECIFIC TO YOUR PROBLEM.

It is likely that one of the products in our portfolio perfectly suits your needs. If this is not the case, our engineers will design a solution that will meet your requirements.

#MORETHANAPLANTBUILDER



Process more material, minimise downtime, build profitability

M&K,
55 Cappagh Road,
Galbally, Dungannon,
Co Tyrone, N Ireland,
BT70 2PD
t: +44 (0) 2887 758396
m +44 (0) 7786 561002
e: desmond.rafferty@the-mkgroup.com
www.the-mkgroup.com



Our policy of continuous development requires that we reserve the right to make changes without specific notice.